



**DEGRENNÉ NORTH AMERICA**  
**CSRV.DNA@DEGRENNÉPARIS.COM**  
**1 732 565 0820**  
**WWW.DEGRENNENORTHAMERICA.COM**



# E B U F F E T E V E N T O

## B U F F E T

Du petit-déjeuner au dîner, des buffets sucrés aux buffets salés, la collection EVENTO répond à tous les scénarios de réception tout en assurant une hygiène parfaite pour satisfaire au mieux les nouvelles exigences de vos clients.

From breakfast to dinner, from sweet buffets to savoury spreads, the EVENTO collection works for all your reception needs while ensuring perfect hygiene to best meet the new requirements of your customers.



# EVENTO

## Buffet



Le buffet EVENTO au design homogène, harmonieux, fonctionnel et modulable, dispose de nombreux produits qui éviteront d'exposer leur contenu à l'air libre tout en conservant les aliments au frais comme au chaud et qui peuvent être utilisés pour la majorité en portion individuelle ou à usage unique. La richesse de ses combinaisons et la diversité de ses matériaux (acier, porcelaine, verre, grès, mélamine pierre et bois etc...) s'adaptent à votre style et à la dimension de votre établissement. La collection EVENTO valorise avec une touche de chic la mise en scène de vos buffets, selon le moment de la journée, de la saison...

The EVENTO buffet with a unified, harmonious, practical and modular design has many products that will avoid exposing their contents to the open air while keeping the food cool as well as warm and which can be used for the most part in individual portions or single use. With a host of combinations and a range of materials to choose from (steel, porcelain, glass, stoneware, melamine, stone and wood...), you can find what works for your style and the size of your space. The EVENTO collection adds a chic touch to your buffet presentations to reflect the time of day or the season.















Termas Chillan, Chili,  
Capacité 109 chambres  
Capacity 109 rooms





## CHAFING DISHES\*

Couvercle en verre transparent pour percevoir le contenu et rendre le buffet plus gourmand

Clear glass cover allows contents to be viewed instantly and makes the buffet more enticing

Charnière avec vérin et amortisseur pour un réel confort d'utilisation et une fermeture en douceur

The hydraulic buffering hinge offers user comfort and convenience with its soft closure mechanism



Encoches pour les couverts de service

The notch for the serving cutlery

Compatible plaque induction, avec résistance électrique ou porte-brûleur avec gel combustible

Compatible with induction, electrical and/or «sterno» fuel heating system

Acier inoxydable, couvercle avec gouttière, verre trempé, système de récupération d'eau de condensation

Stainless steel, lid with groove, condensation water collection system in the porcelain insert

35,5 CM - 14 IN

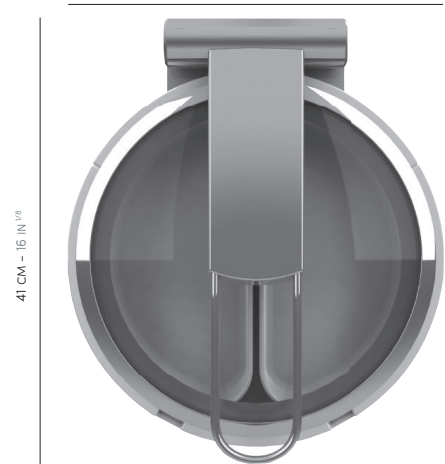

41 CM - 16 IN<sup>5/8</sup>

Ø 35,5 CM X P 41 CM X H 15 CM  
Ø 14 IN X D 16 IN<sup>5/8</sup> X H 5 IN<sup>7/8</sup>

2 FINITIONS  
FINISHES

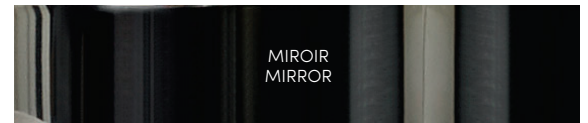

MIROIR  
MIRROR



BROSSÉ  
BRUSHED

\*Certaines pièces sont disponibles en pièces détachées  
Some items are available individually



Le Chafing dish, par son design contemporain alliant acier, porcelaine et verre offre à votre buffet une présentation soignée et raffinée.  
The Chafing dish, with its contemporary design that combines steel, porcelain and glass, brings a smart and sophisticated touch to your buffet display.

## CHAFING DISHES\*

**FINITION MIROIR**  
MIRROR FINISH



**FINITION BROSSÉE**  
BRUSHED FINISH



**CHAFING DISH** 236195  
**SANS BAC** Ø 35,5 CM - P 41 CM - H 15 CM  
**ACIER INOXYDABLE** Ø 14 IN - D 16 IN<sup>1/8</sup> - H 5 IN<sup>7/8</sup>  
**+ COUVERCLE**  
**AVEC GOUTTIÈRE**  
**VERRE TREMPÉ**  
CHAFING DISH  
WITHOUT INSERT  
STAINLESS STEEL  
+ LID WITH GROOVE,  
TEMPERED GLASS

**236194**  
Ø 35,5 CM - P 41 CM - H 15 CM  
Ø 14 IN - D 16 IN<sup>1/8</sup> - H 5 IN<sup>7/8</sup>

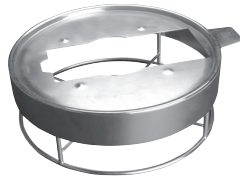

**SUPPORT CHAFING** 203005  
**ACIER INOXYDABLE** Ø 35 CM - P 40 CM - H 12,5 CM  
**POUR RÉSISTANCE ÉLECTRIQUE** Ø 13 IN<sup>3/4</sup> - D 15 IN<sup>3/4</sup> - H 4 IN<sup>5/16</sup>  
**OU PORTE-BRÛLEUR**  
**AVEC GEL COMBUSTIBLE**  
CHAFING STAND STAINLESS STEEL,  
FOR ELECTRICAL AND/OR  
STERNO HEATING PURPOSES

**202859**  
Ø 35 CM - P 40 CM - H 12,5 CM  
Ø 13 IN<sup>3/4</sup> - D 15 IN<sup>3/4</sup> - H 4 IN<sup>5/16</sup>

\*Certaines pièces sont disponibles en pièces détachées  
Some items are available individually

**ACIER**  
STAINLESS STEEL

**PORCELAINE**  
PORCELAIN



**COUVERCLE** 203470  
**AVEC GOUÏTIÈRE ACIER,**  
**VERRE TREMPÉ**  
LID WITH STAINLESS STEEL  
GUTTER,  
TEMPERED GLASS



**BAC POUR** 216142  
**CHAFING DISH**  
CHAFING INSERT  
CONTENANCE 3L  
Ø 14 X 2 IN<sup>3/4</sup>  
CAPACITY 100 OZ



**215721**  
Ø 35,6 X H 7 CM  
CONTENANCE 3L  
Ø 14 X 2 IN<sup>3/4</sup>  
CAPACITY 100 OZ



**RÉSISTANCE** 202860  
**AVEC RÉGULATEUR**  
**DE TEMPÉRATURE**  
HEATING ELEMENT -  
HEAT ADJUSTABLE

220 /240 V /200 W  
20 X 20 CM - 7 IN<sup>7/8</sup> X 7 IN<sup>7/8</sup>  
**203468**  
110 /120 V  
20 X 20 CM - 7 IN<sup>7/8</sup> X 7 IN<sup>7/8</sup>



**1/2 BAC PORCELAINE**  
**POUR**  
**CHAFING DISH**  
1/2 CHAFING  
PORCELAIN INSERT

**202635\***  
L 29 X L 15 X H 4,5 CM  
CONTENANCE 1L  
11 IN<sup>7/16</sup> X 5 IN<sup>7/8</sup> X 1 IN<sup>3/4</sup>  
CAPACITY 33 OZ<sup>13/16</sup>



**PORTE-BRÛLEUR** 243950  
**POUR GEL**  
**COMBUSTIBLE ACIER**  
BURNER HOLDER STEEL

Ø 9 CM - H 6 CM - 33 CL  
Ø 3 IN<sup>9/16</sup> X 2 IN<sup>3/8</sup> - 11 OZ<sup>3/16</sup>



**1/2 BAC PORCELAINE**  
**POUR CHAFING DISH**  
**AVEC SÉPARATEUR**  
1/2 CHAFING  
PORCELAIN INSERT

**236684\***  
L 29,3 CM X H 4,6 CM  
L 11 IN<sup>9/16</sup> X H 1 IN<sup>13/16</sup>

**\*À commander obligatoirement avec le bac pour chafing dish (216142 ou 215721)**  
Must be ordered with the chafing insert (216142 or 215721)





3 FINITIONS  
FINISHES



**FINITION MIROIR**  
MIRROR FINISH



**FINITION BROSSÉE**  
BRUSHED FINISH



**FINITION NOIR MÉTALLISÉ**  
METALLIC BLACK FINISH



**MODULE ACIER** **202864**  
**+ BAC PLASTIQUE<sup>(1)</sup>**  
REFRIGERATED SET  
+ PLASTIC TRAY

**GN1/1**  
L 56,5 CM - P 36 CM - H 9,5 CM  
22 IN<sup>1/4</sup> - D 14 IN<sup>3/16</sup> X 3 IN<sup>3/4</sup>

**202865**  
**GN1/1**  
L 56,5 CM - P 36 CM - H 9,5 CM  
22 IN<sup>1/4</sup> - D 14 IN<sup>3/16</sup> X 3 IN<sup>3/4</sup>

**202869**  
**GN1/1**  
L 56,5 CM - P 36 CM - H 9,5 CM  
22 IN<sup>1/4</sup> - D 14 IN<sup>3/16</sup> X 3 IN<sup>3/4</sup>

**235356**  
**GN1/2**  
29,5 X 35,6 CM  
11 IN<sup>5/8</sup> X 14 IN

**235361**  
**GN1/2**  
29,5 X 35,6 CM  
11 IN<sup>5/8</sup> X 14 IN

**235362**  
**GN1/2**  
29,5 X 35,6 CM  
11 IN<sup>5/8</sup> X 14 IN



**COUVERCLE** **202871**  
**MODULE RÉFRIGÉRÉ**  
**POIGNÉE INOXYDABLE**  
LID FOR REFRIGERATED SET/  
STAINLESS STEEL HANDLE

56 X 35 X 19 CM  
22 IN<sup>1/16</sup> X 13 IN<sup>3/4</sup> X 7 IN<sup>1/2</sup>

**PLAQUE EUTECTIQUE** **208357**  
**NOIRE POUR**  
**MODULE FROID**  
BLACK COOLING  
EUTECTIQUE BLOCK  
FOR UNIT

**GN1/1**  
48 X 28 X 3 CM  
18 IN<sup>7/8</sup> X 11 IN X 1 IN<sup>3/16</sup>



**239786**  
**GN1/2**  
18 X 25 CM  
7 IN<sup>18/16</sup> X 9 IN<sup>13/16</sup>

\*Certaines pièces sont disponibles en pièces détachées  
Some items are available individually

**(1) Garantie lave-vaisselle**  
Dish washer safe



Le module réfrigéré reçoit une large gamme de contenants, plateaux et accessoires multi-matériaux au format GN en porcelaine, verre, acier, acrylique, mélamine pierre et mélamine bois. Ils permettent une infinité de combinaisons.

The refrigerated unit will hold a wide range of platters and multi-material accessories in Industry standard format in porcelain, glass, steel, acrylic stone and wood melamine allowing endless combinations.

**PLATEAUX POUR MODULES FROIDS** PLATTERS FOR REFRIGERATED UNITS

**MÉLAMINE BOIS<sup>(1)</sup>**  
WOOD MELAMINE TRAY



**MÉLAMINE PIERRE<sup>(1)</sup>**  
STONE MELAMINE TRAY



**ACIER 18/10 NEWPORT**  
**FINITION MIROIR**  
SERVING TRAY STAINLESS STEEL  
18/10 MIRROR FINISHED



**PLATEAUX**  
TRAYS

**234546**  
**GN1/1**  
53,5 X 32,5 CM  
20 IN<sup>7/8</sup> X 12 IN<sup>13/16</sup>

**234548**  
**GN 2/3**  
35,4 X 32,5 CM  
13 IN<sup>15/16</sup> X 12 IN<sup>13/16</sup>

**234551**  
**GN 1/2**  
26,4 X 32,5 CM  
10 IN<sup>3/8</sup> X 12 IN<sup>13/16</sup>

**234553**  
**GN 1/3**  
17,5 X 32,5 CM  
6 IN<sup>7/8</sup> X 12 IN<sup>13/16</sup>

**234547**  
**GN1/1**  
53,5 X 32,5 CM  
20 IN<sup>7/8</sup> X 12 IN<sup>13/16</sup>

**234549**  
**GN 2/3**  
35,4 X 32,5 CM  
13 IN<sup>15/16</sup> X 12 IN<sup>13/16</sup>

**234552**  
**GN 1/2**  
26,4 X 32,5 CM  
10 IN<sup>3/8</sup> X 12 IN<sup>13/16</sup>

**234554**  
**GN 1/3**  
17,5 X 32,5 CM  
6 IN<sup>7/8</sup> X 12 IN<sup>13/16</sup>

**238962**  
**GN1/1**  
53,5 X 32,5 CM  
20 IN<sup>7/8</sup> X 12 IN<sup>13/16</sup>

**238960**  
**GN 1/2**  
26,4 X 32,5 CM  
10 IN<sup>3/8</sup> X 12 IN<sup>13/16</sup>



**PLATEAUX**  
**3 TROUS**  
3 HOLES TRAYS

**234557**  
**GN 1/6**  
8,7 X 32,5 CM  
3 IN<sup>7/16</sup> X 12 IN<sup>13/16</sup>



**234558**  
**GN 1/6**  
8,7 X 32,5 CM  
3 IN<sup>7/16</sup> X 12 IN<sup>13/16</sup>

(1) Compatible lave-vaisselle, NON compatible micro-ondes  
Dish washer safe, DONT USE with micro-wave

**VERRE ÉPAISSEUR 0,6 CM**  
TEMPERED GLASS THICKNESS 1/4

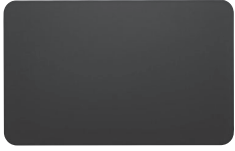

**230752**  
**GN 1/1**  
53,5 X 32,5 CM  
20 IN<sup>7/8</sup> X 12 IN<sup>13/16</sup>

**230753**  
**GN 2/3**  
35,4 X 32,5 CM  
13 IN<sup>15/16</sup> X 12 IN<sup>13/16</sup>

**ACRYLIQUE ÉPAISSEUR 1 CM**  
ACRYLIC THICKNESS 3/8

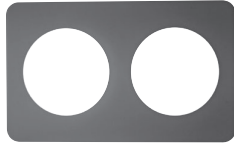

**230756**  
**GN 1/1 - 2 TROUS**  
2 HOLES  
53,5 X 32,5 CM - 20 IN<sup>7/8</sup> X 12 IN<sup>13/16</sup>

**230757**  
**GN 1/3 - 2 TROUS - BOLS 14 CM**  
2 HOLES - BOWLS 5,5 IN  
17,5 X 32,5 CM - 6 IN<sup>7/8</sup> X 12 IN<sup>13/16</sup>

**GRÈS CARBONE (2)**  
GREY STONEWARE



**234550**  
**GN 2/3**  
35,4 X 32,5 CM  
13 IN<sup>15/16</sup> X 12 IN<sup>13/16</sup>

**234555**  
**GN 1/3**  
17,5 X 32,5 CM  
6 IN<sup>7/8</sup> X 12 IN<sup>13/16</sup>



**PLATEAU  
À REBORDS**  
EDGE TRAY

**234556**  
**GN 1/3**  
17,5 X 32,5 CM  
6 IN<sup>7/8</sup> X 12 IN<sup>13/16</sup>

**PORCELAINE (2)**  
WHITE ENAMELLED PORCELAIN



**202628**  
**GN 2/3**  
35,4 X 32,5 CM  
13 IN<sup>15/16</sup> X 12 IN<sup>13/16</sup>

**202629**  
**GN 1/2**  
26,4 X 32,5 CM  
10 IN<sup>3/8</sup> X 12 IN<sup>13/16</sup>

**202627**  
**GN 1/3**  
17,5 X 32,5 CM  
6 IN<sup>7/8</sup> X 12 IN<sup>13/16</sup>



**PLAT CREUX  
PORCELAINE**  
PORCELAIN  
DEEP DISH

**202630**  
**GN 1/3**  
17,5 X 32,5 CM  
6 IN<sup>7/8</sup> X 12 IN<sup>13/16</sup>

## URNES À JUS DE FRUITS\* FRUIT JUICE URNS

Urne à jus de fruit dotée d'un tube central en acier pour glace pilée : parfait maintien de la fraîcheur  
Fruit juice urn with central steel tube to hold crushed ice, for perfect freshness



**FINITION MIROIR**  
MIRROR FINISH

**FINITION BROSSÉE**  
BRUSHED FINISH

**URNE À JUS DE FRUITS 5L ACIER 18-10** **222883**  
L 20 CM X P 32 CM X H 45 CM  
W 7 IN<sup>7/8</sup> X D 12 IN<sup>5/8</sup> X H 17 IN<sup>11/16</sup>  
JUICE DISPENSER 169 OZ  
STAINLESS STEEL

**231304**  
L 20 CM X P 32 CM X H 45 CM  
W 7 IN<sup>7/8</sup> X D 12 IN<sup>5/8</sup> X H 17 IN<sup>11/16</sup>

**CRISTALLIN SOUFLÉ BOUCHE**  
HAND BLOWN CRYSTALLINE



**CARAFE À JUS DE FRUIT - 1,2 L** **202639**  
Ø 10,5 CM - H 27,5 CM  
JUICE/BEVERAGE Ø 4 IN<sup>1/8</sup> X H 10 IN<sup>13/16</sup>  
CARAFE - 40 OZ<sup>9/16</sup>

**PORCELAINE**  
PORCELAIN



**CARAFE À LAIT - 1,2 L** **202636**  
Ø 10,5 CM - H 27,5 CM  
MILK JUG Ø 4 IN<sup>1/8</sup> X H 10 IN<sup>13/16</sup>  
- 40 OZ<sup>9/16</sup>

Bouchon verseur, pour une meilleure hygiène  
Hygienic pouring stopper



**BOUCHON DE CARAFE SILICONE** **202855**  
Ø 6,5 CM - H 4,2 CM  
STOPPER FOR CARAFE SILICONE Ø 2 IN<sup>9/16</sup> X H 1 IN<sup>5/8</sup>

\*Certaines pièces sont disponibles en pièces détachées  
Some items are available individually

## DISTRIBUTEURS À CÉRÉALES\* CEREAL DISPENSERS

Distributeur à céréales 1 ou 3 tubes avec ailettes souples pour ne pas casser les céréales  
Cereal dispenser 1 or 3 tubs with flexible spout so as not to break the cereals



X3

**DISTRIBUTEUR À CÉRÉALES 231300**  
CEREAL DISPENSER L 50 CM X P 20 CM X H 55,5 CM  
W 19 IN<sup>11/16</sup> X D 7 IN<sup>7/8</sup> X H 21 IN<sup>7/8</sup>  
CAPACITÉ : 3 X 3,5 L  
CAPACITY : 3 X 1 GAL



X1

**231299**  
L 19 CM X P 20 CM X H 55,5 CM  
W 7 IN<sup>1/2</sup> X D 7 IN<sup>7/8</sup> X H 21 IN<sup>7/8</sup>  
CAPACITÉ : 3,5 L  
CAPACITY : 1 GAL



**RAFRAICHISSEUR 237501**  
**DROIT** Ø 13,9 X H 19,8 CM  
**DOUBLE PAROI** Ø 5 IN<sup>7/8</sup> X H 7 IN<sup>13/16</sup>  
CURVED  
DOUBLE WALL  
WINE COOLER



**BOL 154245**  
**PORCELAINE** **MODULO BLANC**  
PORCELAIN BOWL WHITE MODULO  
14 CM - 5 IN<sup>1/2</sup>  
**202626**  
**EMPILABLE**  
STACKABLE



**ETIQUETTE PORCELAINE 202632**  
**AVEC AIMANT** 10 X 5 CM  
**+ SUPPORT ACIER** 3 IN<sup>15/16</sup> X 1 IN<sup>15/16</sup>  
PORCELAIN STICK +  
STAINLESS STEEL STAND  
WITH MAGNET

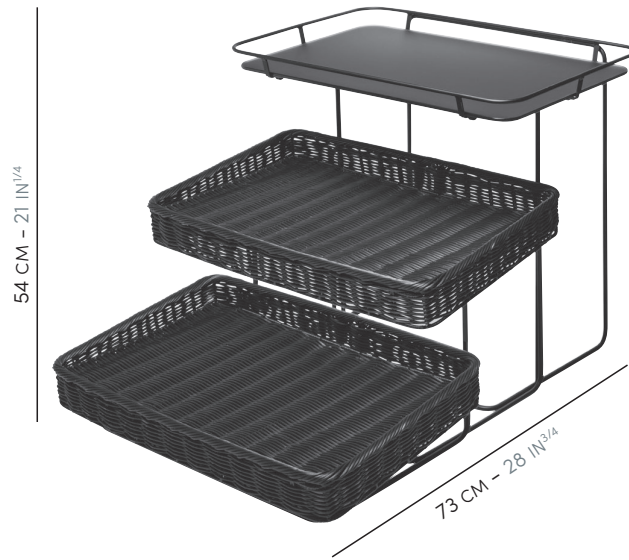

Panière reversible pour une présentation droite ou inclinée  
Reversible basket for a level or titled display



Des supports en acier noir mat de hauteurs différentes pour rythmer les présentations.  
Black mat finish supports of differing heights can be used to create a varied presentation.



## SUPPORTS À FIL RECTANGULAIRES RECTANGULAR TRAYS



1

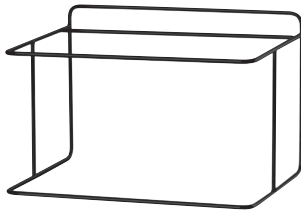

2

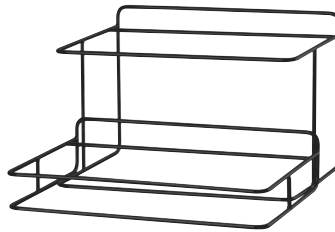

1 + 2



**PANIÈRE 230749**  
**RECTANGULAIRE GN 1/1**  
 RECTANGULAR 54 X 34 X H 7 CM  
 BREAD BASKET 21 IN<sup>1/4</sup> X 13 IN<sup>3/8</sup> X 2 IN<sup>3/4</sup>

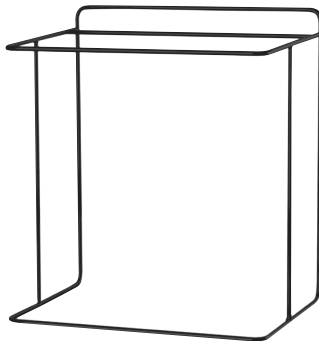

3

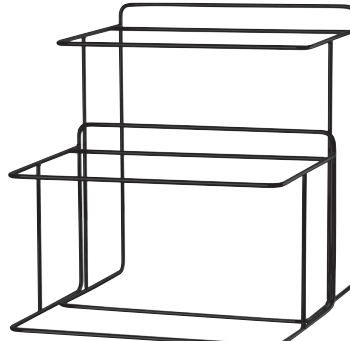

2 + 3



1 + 2 + 3

**SUPPORT 230741**  
**RECTANGULAIRE**  
 RECTANGULAR TRAY  
**NIVEAU 1 - LEVEL 1**  
 L 44 X P 30,8 X H 10,8 CM  
 W 17 IN<sup>5/16</sup> X D 12 IN<sup>1/8</sup> X H 4 IN<sup>1/4</sup>

**230742**  
**NIVEAU 2 - LEVEL 2**  
 L 42 X P 30,8 X H 29,8 CM  
 W 16 IN<sup>5/16</sup> X D 12 IN<sup>1/8</sup> X H 11 IN<sup>3/4</sup>

**230743**  
**NIVEAU 3 - LEVEL 3**  
 L 40 X P 30,8 X H 48,8 CM  
 W 15 IN<sup>3/4</sup> X D 12 IN<sup>1/8</sup> X H 19 IN<sup>3/16</sup>

**230741 + 230742**  
**NIVEAU 1 + 2 - LEVEL 1+2**  
 L 44 X P 50 X H 29,8 CM  
 W 17 IN<sup>5/16</sup> X D 19 IN<sup>1/16</sup> X H 11 IN<sup>3/4</sup>

**230742 + 230743**  
**NIVEAU 2 + 3 - LEVEL 2+3**  
 L 42 X P 50 X H 48,8 CM  
 W 16 IN<sup>5/16</sup> X D 19 IN<sup>1/16</sup> X H 19 IN<sup>3/16</sup>

**230741 + 230742 + 230743**  
**NIVEAU 1 + 2 + 3 - LEVEL 1+2+3**  
 L 44 X P 68,2 X H 48,8 CM  
 W 17 IN<sup>5/16</sup> X D 26 IN<sup>7/8</sup> X H 19 IN<sup>3/16</sup>

## SUPPORTS À FIL RONDS ROUND TRAYS

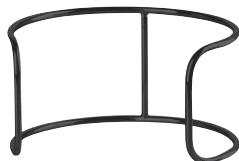

**SUPPORT 230745**  
**ROUND BAS**  
 ROUND STAND  
**LOW LEVEL**  
 Ø 25 CM X H 13 CM  
 Ø 9 IN<sup>13/16</sup> X H 5 IN<sup>1/8</sup>

**230746**  
**HAUT**  
 HIGH LEVEL  
 Ø 25 CM X H 26 CM  
 Ø 9 IN<sup>13/16</sup> X H 10 IN<sup>1/4</sup>

**GRÈS CARBONÉ<sup>(0)</sup>**  
 GREY STONEWARE



**SALADIER 234564**  
**BAS** Ø 25,4 X 7 CM - 2,4 L  
 SALAD BOWL  
 Ø 10 IN X 2 IN<sup>3/4</sup> - 80 OZ<sup>1/8</sup>



**PANIÈRES 230750**  
**BREAD BASKETS**  
**INDIVIDUELLE**  
 INDIVIDUAL  
 Ø 18 CM X 6 CM  
 Ø 7 IN<sup>1/16</sup> X 2 IN<sup>3/8</sup>

**230748**  
**RONDE**  
 ROUND  
 Ø 32 CM X H 8 CM  
 Ø 12 IN<sup>5/8</sup> X H 3 IN<sup>1/8</sup>

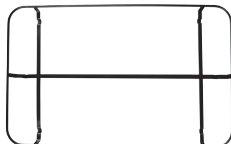

**CADRE ACIER 230744**  
**POUR SUPPORT** L 55,5 X P 35 X H 4,5 CM  
**RECTANGULAIRE<sup>(1)</sup>** W 21 IN<sup>7/8</sup> X D 13 IN<sup>3/4</sup> X H 1 IN<sup>3/4</sup>  
 STEEL FRAME FOR STAND

**MÉLAMINE BOIS<sup>(2)</sup>**  
 WOOD MELAMINE TRAY



**PLATEAUX 234546**  
 TRAYS  
**GN1/1**  
 53,5 X 32,5 CM  
 20 IN<sup>7/8</sup> X 12 IN<sup>13/16</sup>

**MÉLAMINE PIERRE<sup>(2)</sup>**  
 STONE MELAMINE TRAY



**234547**  
**GN1/1**  
 53,5 X 32,5 CM  
 20 IN<sup>7/8</sup> X 12 IN<sup>13/16</sup>

**ACIER 18/10 NEWPORT**  
**FINITION MIROIR**  
 SERVING TRAY STAINLESS STEEL  
 18/10 MIRROR FINISHED



**238962**  
**GN1/1**  
 53,5 X 32,5 CM  
 20 IN<sup>7/8</sup> X 12 IN<sup>13/16</sup>

**VERRE ÉPAISSEUR 0,6 CM**  
 TEMPERED GLASS THICKNESS IN<sup>1/4</sup>

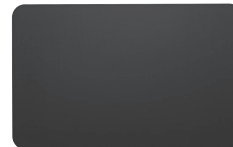

**230752**  
**GN1/1**  
 53,5 X 32,5 CM  
 20 IN<sup>7/8</sup> X 12 IN<sup>13/16</sup>

**(2) Compatible lave-vaisselle, NON compatible micro-ondes**  
 Dish washer safe, DONT USE with micro-wave

**MÉLAMINE BOIS<sup>(2)</sup>**  
 WOOD MELAMINE TRAY



**PLATEAUX 234561**  
**RONDS** Ø 32 CM  
 ROUND 12 IN<sup>5/8</sup>  
 TRAYS

**MÉLAMINE PIERRE<sup>(2)</sup>**  
 STONE MELAMINE TRAY



**234562**  
 Ø 32 CM  
 12 IN<sup>5/8</sup>

**PORCELAINE MODULO**  
 MODULO PORCELAIN  
 PIE/PIZZA PLATE, FLAT



**136524**  
 Ø 32 CM  
 12 IN<sup>5/8</sup>

**(1) Compatible lave-vaisselle, Compatible micro-ondes**  
 Dish washer safe, Micro-wave safe

**(2) Compatible lave-vaisselle, NON compatible micro-ondes**  
 Dish washer safe, DONT USE with micro-wave safe



**PLANCHES LES ESSENCES** BOARDS **-NEW-**

**CHÊNE**  
OAK



**PLANCHE RONDE** **242942**  
ROUND BOARD 29,4 CM - 11 IN<sup>9/16</sup>  
EPAISSEUR - 2 CM  
THICKNESS - IN<sup>9/16</sup>

**NOYER**  
WALNUT



**PLANCHE RONDE** **242946**  
ROUND BOARD 29,4 CM - 11 IN<sup>9/16</sup>  
EPAISSEUR - 2 CM  
THICKNESS - IN<sup>9/16</sup>

**COMPATIBLE AVEC**  
**LA CLOCHE EVENTO 239771**  
COMPATIBLE WITH  
EVENTO DOME COVER



**PLANCHE BAHIA** **242941**  
BAHIA BOARD 35 X 21 CM - 13 IN<sup>3/4</sup> X 8 IN<sup>1/4</sup>  
EPAISSEUR - 2 CM  
THICKNESS - IN<sup>9/16</sup>



**PLANCHE BAHIA** **242945**  
BAHIA BOARD 35 X 21 CM - 13 IN<sup>3/4</sup> X 8 IN<sup>1/4</sup>  
EPAISSEUR - 2 CM  
THICKNESS - IN<sup>9/16</sup>



**PLANCHE CARREE** **242940**  
SQUARE BOARD 36,7 X 30 CM - 14 IN<sup>7/16</sup> X 11 IN<sup>13/16</sup>  
EPAISSEUR - 2 CM  
THICKNESS - IN<sup>9/16</sup>



**PLANCHE CARREE** **242944**  
SQUARE BOARD 36,7 X 30 CM - 14 IN<sup>7/16</sup> X 11 IN<sup>13/16</sup>  
EPAISSEUR - 2 CM  
THICKNESS - IN<sup>9/16</sup>



**PLANCHE ALLONGEE** **242939**  
LONG BOARD 50 X 21 CM - 19 IN<sup>11/16</sup> X 8 IN<sup>1/4</sup>  
EPAISSEUR - 2 CM  
THICKNESS - IN<sup>9/16</sup>



**PLANCHE ALLONGEE** **242943**  
LONG BOARD 50 X 21 CM - 19 IN<sup>11/16</sup> X 8 IN<sup>1/4</sup>  
EPAISSEUR - 2 CM  
THICKNESS - IN<sup>9/16</sup>

**ACCESSOIRES** ACCESSORIES

**PIERRE DE LUNE**  
MOONSTONE  
Porcelaine - Porcelain



**SALADIER** 239325  
BOWL 28 CM - 11 IN  
4L - 135 OZ 1/4

**DUNE**  
BEIGE DUNE  
Grès - Stoneware



**235223**  
28 CM - 11 IN  
4L - 135 OZ 1/4

**BLEU DE ROCHE**  
BLUE STONE  
Grès - Stoneware



**235222**  
28 CM - 11 IN  
4L - 135 OZ 1/4

**ONYX**  
BLACK ONYX  
Grès - Stoneware



**240499**  
28 CM - 11 IN  
4L - 135 OZ 1/4

**ARGILE VERTE**  
GREEN CLAY  
Grès - Stoneware



**PLANCHE** 242054  
**RECTANGULAIRE** 35 x 21 CM  
RECTANGULAR BOARD  
13 IN<sup>3/4</sup> x 8 IN<sup>1/4</sup>



**242056**  
35 x 21 CM  
13 IN<sup>3/4</sup> x 8 IN<sup>1/4</sup>



**242052**  
35 x 21 CM  
13 IN<sup>3/4</sup> x 8 IN<sup>1/4</sup>



**237206**  
25 X 13,5 CM  
9 IN<sup>13/16</sup> X 5 IN<sup>5/16</sup>



**234949**  
25 X 13,5 CM  
9 IN<sup>13/16</sup> X 5 IN<sup>5/16</sup>



**PLANCHE** 242055  
**RONDE** 29 CM - 11 IN<sup>7/16</sup>  
ROUND BOARD



**242057**  
29 CM - 11 IN<sup>7/16</sup>

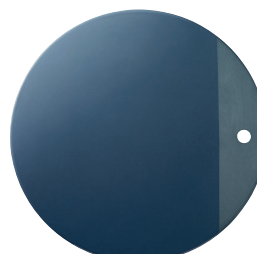

**242053**  
29 CM - 11 IN<sup>7/16</sup>



**PLAT** 241835  
**GRAND MODÈLE** 31,8 x 25 x 7,4 CM  
LARGE DISH 12 IN<sup>1/2</sup> x 9 IN<sup>13/16</sup> x 2 IN<sup>15/16</sup>



**237595**  
31,8 x 25 x 7,4 CM  
12 IN<sup>1/2</sup> x 9 IN<sup>13/16</sup> x 2 IN<sup>15/16</sup>

**PLAT** 241834  
**MOYEN MODÈLE** 22,8 x 16,2 x 5,4 CM  
MEDIUM DISH 9 IN x 6 IN<sup>3/8</sup> x 2 IN<sup>1/8</sup>

**237594**  
22,8 x 16,2 x 5,4 CM  
9 IN x 6 IN<sup>3/8</sup> x 2 IN<sup>1/8</sup>

**PLAT** 241833  
**PETIT MODÈLE** 15,5 x 10,7 x 4,4 CM  
SMALL DISH 6 IN<sup>7/8</sup> x 4 IN<sup>3/16</sup> x 1 IN<sup>3/4</sup>

**237593**  
15,5 x 10,7 x 4,4 CM  
6 IN<sup>7/8</sup> x 4 IN<sup>3/16</sup> x 1 IN<sup>3/4</sup>



**PLANCHE À PAIN  
BAMBOU AVEC  
RÉCUPÉRATEUR DE MIETTES** **202854**  
GN 1/1 53 X 32,5 CM  
BAMBOO BREAD BOARD  
WITH CRUMB TRAY 20 IN<sup>7/8</sup> X 12 IN<sup>3/16</sup>



**COUTEAU À PAIN** **229516**  
L'ECONOME BY STARCK® 24 CM - 9 IN<sup>7/16</sup>  
POSITIONNABLE  
DANS LA PLANCHE  
L'ECONOME BY STARCK®  
BREAD KNIFE FITS IN A SLOT IN  
THE BREAD BOARD



**PRÉSENTOIR** **209381**  
À GÂTEAUX ROND Ø 25 CM - 9 IN<sup>13/16</sup>  
ROUND APP/PIZZA/  
PRESENTATION STAND **209382**  
Ø 32 CM - 12 IN<sup>5/16</sup>



**CLOCHE EVENTO VERRE** **239769**  
EVENTO DOME COVER Ø 16 CM - 6 IN<sup>5/16</sup>

**239770**  
Ø 23 CM - 9 IN<sup>1/6</sup>

**239771**  
Ø 28 CM - 11 IN

**MÉLAMINE BOIS<sup>(2)</sup>**  
WOOD MELAMINE TRAY



**(1) PLANCHA** **234559**  
AVEC MANCHE 17,5 X 45 CM  
BOARD 6 IN<sup>7/8</sup> X 17 IN<sup>11/16</sup>

**MÉLAMINE PIERRE<sup>(2)</sup>**  
STONE MELAMINE TRAY



**234560**  
17,5 X 45 CM  
6 IN<sup>7/8</sup> X 17 IN<sup>11/16</sup>



**SALADIER 202625**  
**PORCELAINE** 23 CM - 9 IN<sup>1/16</sup>  
**EVENTO BLANC** H : 9,6 CM - 3 IN<sup>3/4</sup>  
 WHITE EVENTO CONTENANCE : 2 L  
 SALAD BOWL CAPACITY : 67 OZ<sup>5/8</sup>



**SALADIER 142722**  
**PORCELAINE** 28 CM - 11 IN  
**MODULO** H : 12 CM - 4 IN<sup>3/4</sup>  
 DEEP SALAD CONTENANCE : 2,5 L  
 BOWL, LARGE CAPACITY : 84 OZ<sup>2/16</sup>



**SUPPORT COUVERTS 202633**  
**DE SERVICE** 21 X 10 X 5 CM  
**PORCELAINE** 8 IN<sup>1/4</sup> X 3 IN<sup>5/16</sup> X 1 IN<sup>15/16</sup>  
 SERVING  
 CUTLERY DISPLAY  
 WHITE PORCELAIN



**ETIQUETTE 202632**  
**PORCELAINE** 10 X 5 CM  
**AVEC AIMANT** 3 IN<sup>5/16</sup> X 1 IN<sup>15/16</sup>  
**+ SUPPORT ACIER**  
 PORCELAIN STICK +  
 STAINLESS STEEL STAND  
 WITH MAGNET



**LOUCHE 153193**  
**ASTRÉE MIROIR**  
 SOUP LADLE 29,7 CM - 11 IN<sup>11/16</sup>



**CISEAUX 204496**  
**À GÂTEAUX** 101494  
 PASTRY 20 CM - 7 IN<sup>7/8</sup>  
 SCISSORS/TONG



**PINCE À SERVIR 204499**  
**SERVING TONG** 184355  
 29,5 CM - 11 IN<sup>5/8</sup>



**PINCE À PAIN 204498**  
**BREAD TONG** 101492  
 23 CM - 9 IN<sup>1/16</sup>

(1) Planche de présentation uniquement, ne pas faire de découpe  
 Presentation board, dont cut on it

(2) Compatible lave-vaisselle, NON compatible micro-ondes  
 Dish washer safe, DONT USE with micro-wave

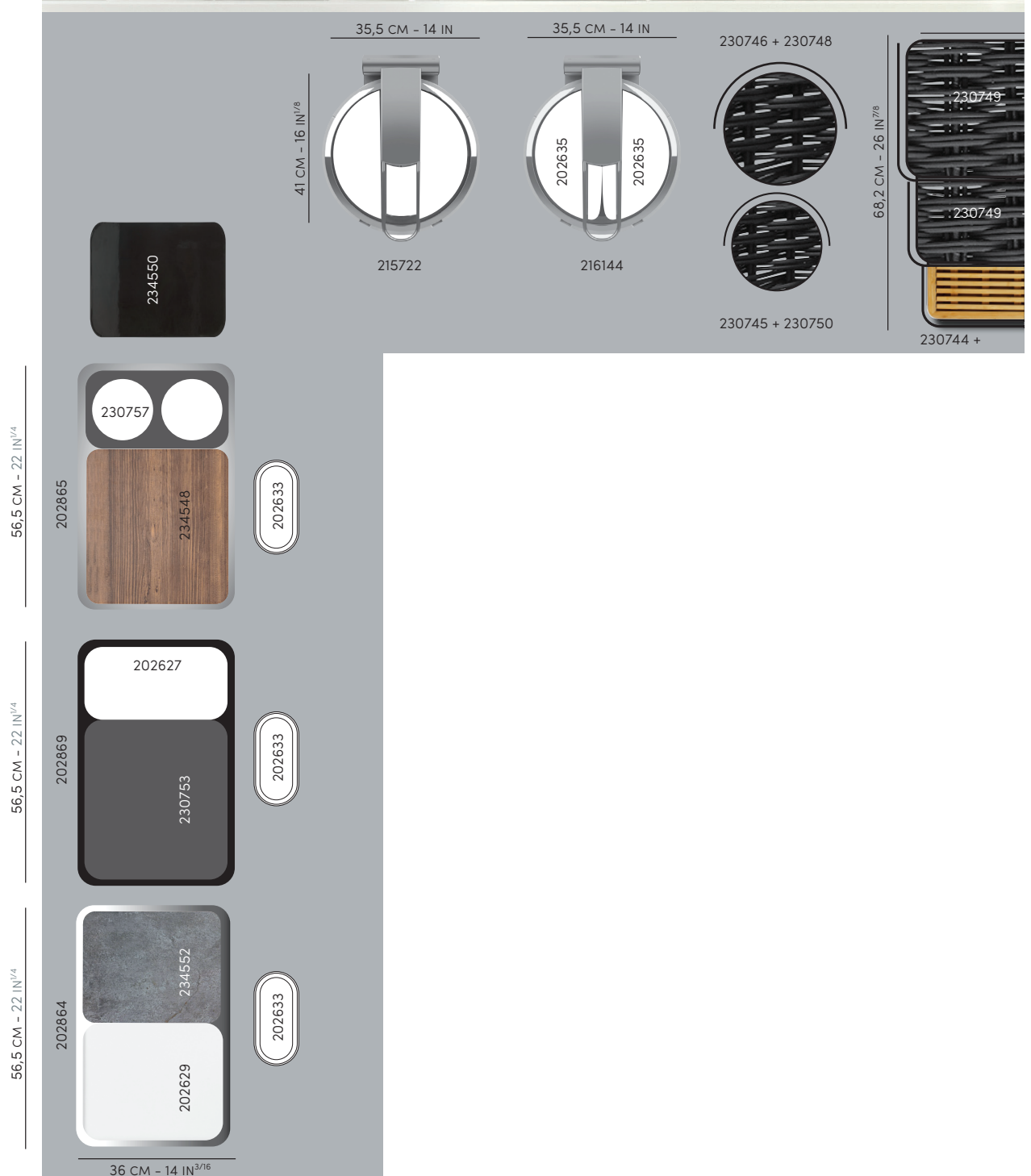



44 CM - 14 IN



230743

230742

202854 + 230741



242055

29 CM - 11 IN<sup>7/16</sup>



239325

Ø 28 CM  
Ø 11 IN



240499

234562  
Ø 32 CM - 12 IN<sup>5/8</sup>



239771  
Ø 28 cm  
Ø 11 in

Ø 32 cm  
Ø 12 in<sup>5/8</sup>

35.5 CM - 14 IN  
209382

20 CM - 7 IN<sup>7/8</sup>



237593

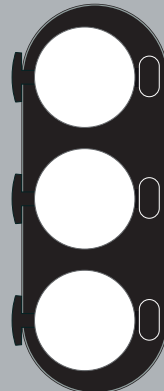

231300

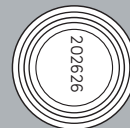

202626

32 CM - 12 IN<sup>5/8</sup>

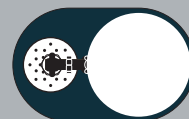

231303

20 CM  
7 IN<sup>7/8</sup>

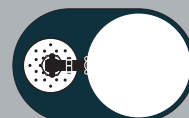

231303

20 CM  
7 IN<sup>7/8</sup>

50 CM - 19 IN<sup>11/16</sup>



**CHAFING DISH**

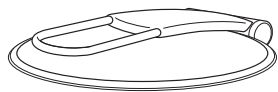

**COUVERCLE AVEC GOUTTIÈRE** 203470  
**ACIER ET VERRE TREMPÉ** Ø 33 CM - Ø 13 IN  
LID WITH STAINLESS STEEL  
GUTTER,  
TEMPERED GLASS

**KIT SAV VÉRINS** 217435  
**POUR CHAFING DISH**  
REPLACING KIT FOR  
CHAFING DISH CYLINDER

**JOINT POUR CHAFING DISH** 230050  
SEAL FOR CHAFING DISH

**MODULE FROID**  
REFRIGERATED UNIT



**BAC PLASTIQUE** 202866  
PLASTIC TRAY 56 X 35,5 X 8 CM  
22 IN<sup>1/8</sup> X 14 IN X 3 IN<sup>1/8</sup>

**235357**  
29,5 X 35,6 CM  
11 IN<sup>5/8</sup> X 14 IN

**URNE À JUS DE FRUITS**  
FRUIT JUICE URN

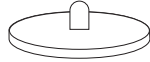

**COUVERCLE URNE** 202881  
**ACIER 18-10** **FINITION MIROIR**  
LID FOR STAINLESS MIRROR FINISH  
DISPENSER 18-10 Ø 17,9 CM  
7 IN<sup>1/16</sup>

202891  
**FINITION BROSSÉE**  
BRUSHED FINISH  
Ø 17,9 CM  
7 IN<sup>1/16</sup>

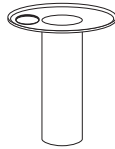

**TUBE ACIER POUR** 202884  
**GLACE** Ø 9 CM - 3 IN<sup>9/16</sup>  
ICE TUBE  
STAINLESS STEEL



**FÛT CYLINDRIQUE** 202883  
**URNE** 5 L - 169 OZ<sup>1/16</sup>  
CONTAINER FOR Ø 17,7 CM X H 25,5 CM  
DISPENSER Ø 6 IN<sup>15/16</sup> X H 10 IN<sup>1/16</sup>

**ROBINET ACIER** 214724  
**ABS NOIR**  
STAINLESS STEEL  
FAUCET BLACK

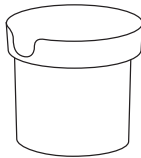

**BASE ACIER** 202890  
**18-10 URNE** **FINITION MIROIR**  
STAINLESS STEEL MIRROR FINISH  
STAND FOR Ø 17,6 CM - H 19 CM  
DISPENSER 18-10 6 IN<sup>15/16</sup> X 7 IN<sup>1/2</sup>

202889  
**FINITION BROSSÉE**  
BRUSHED FINISH  
Ø 17,6 CM - H 19 CM  
6 IN<sup>15/16</sup> X 7 IN<sup>1/2</sup>



**GRILLE ACIER** 045963  
**POUR GOUTTES - 18/10** Ø 9 CM  
STAINLESS STEEL GRID Ø 3 IN<sup>9/16</sup>  
DROP COLLECTOR



**SOCLE NOIR ACRYLIQUE URNE** 230758  
STAND FOR BLACK DISPENSER 20 X 32 CM  
7 IN<sup>7/8</sup> X 12 IN<sup>5/8</sup>  
ÉPAISSEUR : 2 CM  
THICKNESS: 13/16 IN

**DISTRIBUTEUR À CÉRÉALES**  
CEREAL DISPENSER



**COUVERCLE** 213078  
**DISTRIBUTEUR CEREALES** Ø 12,5 CM  
**ACIER FINITION MIROIR - 18/10** Ø 4 IN<sup>15/16</sup>  
LID FOR CEREAL DISPENSER,  
STAINLESS STEEL,  
MIRROR FINISH



**FUT CYLINDRIQUE** 213076  
**AVEC AILETTE ET POIGNEE** P 16,1 X H 42 CM  
**DISTRIBUTEUR CEREALES** D 6 IN<sup>5/16</sup> X H 16 IN<sup>9/16</sup>  
BARREL + HANDLE + ROLLING TAP  
FOR CEREAL DISPENSER

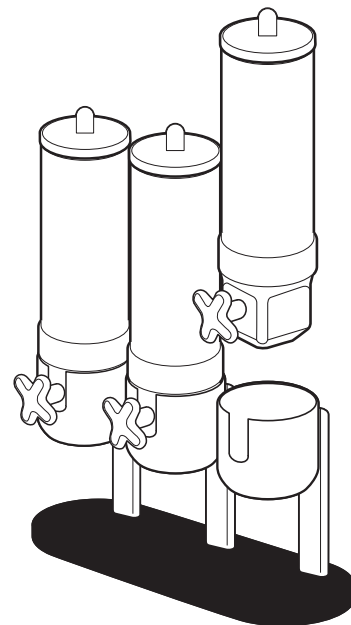

X3

X1

**BASE + TUBE + SOCLE** 231302  
**DISTRIBUTEUR À CEREALES** L 50 X H 27,5 CM  
STAINLESS STEEL STAND + TUB L 19 IN<sup>11/16</sup> X H 29 IN<sup>3/4</sup>  
+ ACRYLIC STAND FOR CEREAL DISPENSER

231301  
L 19 X H 27,5 CM  
L 7 IN<sup>1/2</sup> X H 29 IN<sup>3/4</sup>